



**2430D**

## **Alicates de boca semirredonda con mangos monomateriales**



### DETALLES DEL PRODUCTO

- Mangos de polipropileno
- Capacidad de corte: 2.5 mm a 3 mm de Cu, 1.8 mm de Fe, 1.4 mm a 1.6 mm de Fe +
- Mordazas de forma redonda y serradas para agarrar materiales planos y redondos con gran accesibilidad en espacios reducidos
- Mordazas rectas, con bordes de corte endurecidos para cortar alambre blando y duro
- Aleación de acero de alto rendimiento
- Acabado fosfatado, tratamiento anticorrosión
- Normas: ISO 5745
- IP = Embalaje industrial

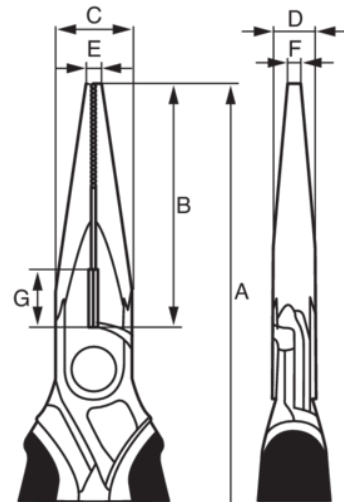





**Follow the Fish!**







## ATRIBUTOS DE PRODUCTO





### Producto: 2430 D-140

<b>A</b>	140 mm	<b>B</b>	37 mm	<b>C</b>	15 mm
<b>D</b>	7.8 mm	<b>E</b>	2.5 mm	<b>F</b>	2 mm
<b>G</b>	12 mm	 2.5 mm	 1.8 mm		
 1.4 mm	 120 g				





### Producto: 2430 D-160

<b>A</b>	160 mm	<b>B</b>	51 mm	<b>C</b>	16.5 mm
<b>D</b>	8.8 mm	<b>E</b>	3 mm	<b>F</b>	2.5 mm
<b>G</b>	12 mm	 3.0 mm	 1.8 mm		
 1.6 mm	 160 g				





### Producto: 2430 D-200

<b>A</b>	200 mm	<b>B</b>	72 mm	<b>C</b>	17 mm
<b>D</b>	9.3 mm	<b>E</b>	3 mm	<b>F</b>	2.5 mm
<b>G</b>	12 mm	 3.0 mm	 1.8 mm		
 1.6 mm	 170 g				





### Producto: 2430 D-140 IP

<b>A</b>	140 mm	<b>B</b>	37 mm	<b>C</b>	15 mm
<b>D</b>	7.8 mm	<b>E</b>	2.5 mm	<b>F</b>	2 mm
<b>G</b>	12 mm	 2.5 mm	 1.8 mm		
 1.4 mm	 120 g				

### Producto: 2430 D-160 IP

<b>A</b>	160 mm	<b>B</b>	51 mm	<b>C</b>	16.5 mm
<b>D</b>	8.8 mm	<b>E</b>	3 mm	<b>F</b>	2.5 mm
<b>G</b>	12 mm	 3.0 mm	 1.8 mm		
 1.6 mm	 160 g				

### Producto: 2430 D-200 IP

<b>A</b>	200 mm	<b>B</b>	72 mm	<b>C</b>	17 mm
<b>D</b>	9.3 mm	<b>E</b>	3 mm	<b>F</b>	2.5 mm
<b>G</b>	12 mm	 3.0 mm	 1.8 mm		
 1.6 mm	 170 g				

